

goodnature®

Smart Trap Kit

Retail Training Guide for the
A24 Rat & Mouse Trap Kits.



Made in New Zealand



Standard or Smart Cap Attachment

The Smart Cap sends trap data to your smartphone via the Goodnature App

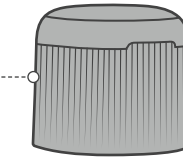

A24 Trap

A self-resetting trapping mechanism that humanely kills the rodent

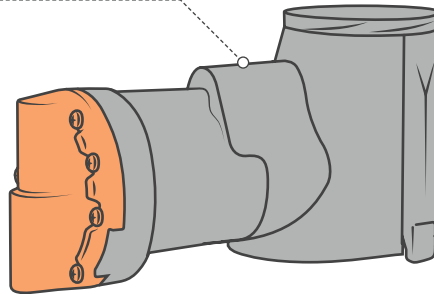

Automatic Paste Pump

Silver foil pouch that slowly releases fresh and attractive paste over 6 months



Tree Mount

Screws onto any tree or wooden post - primarily used outdoors

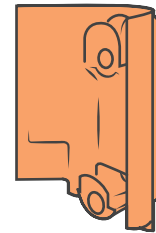

OR

CO2 Gas Canister

Powers your trap for 6 months or 24 kills



Trap Stand

Allows for flexible movability around the property indoors and outdoors

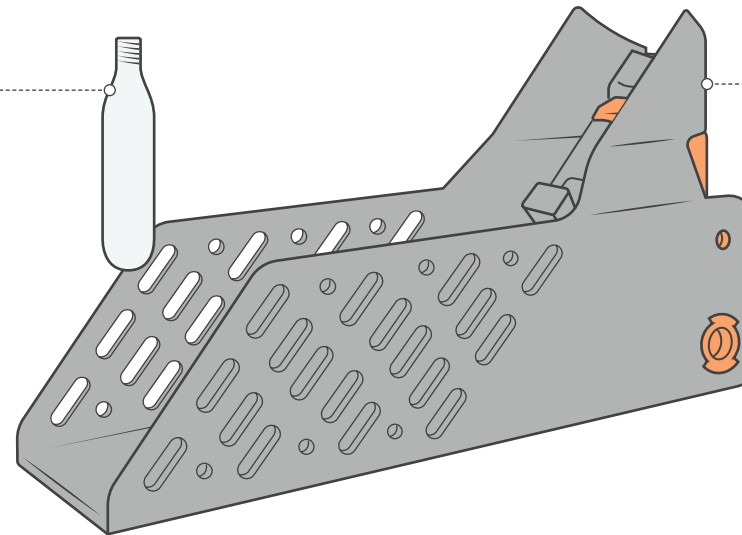

It's called an A24 because it automatically resets 24 times per gas canister



Pet Safe



Non-toxic

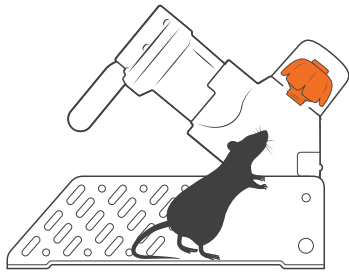

Sniff sniff

Non-toxic paste attracts pests into the trap

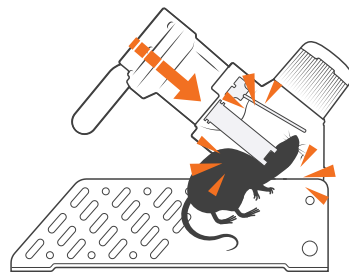

Kapow!

Pest moves the trigger, firing the trap

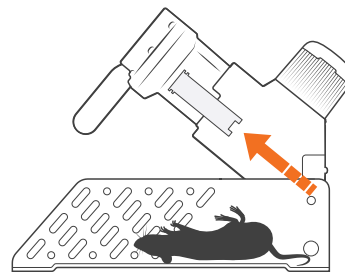

Auto-reset

Pest drops as trap resets itself

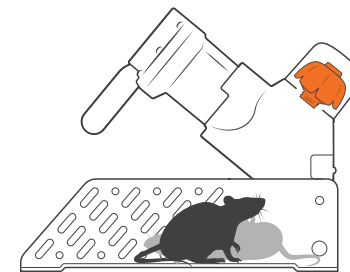

Sniff sniff

Paste continues to attract pests for 6 months

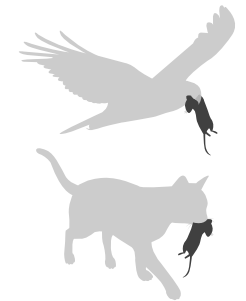

Scavenged

Dead pests are scavenged from below the trap

The A24 Trap, humanely kills pest, helping to protect our native species and wildlife

This is the most important step in setting up your A24 Trap, as a chewed up card indicates where you should install your trap for greater success.

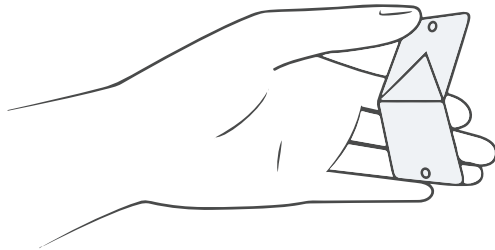
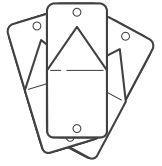

Fold in half

A small amount of paste should squeeze out the middle (for attracting rodents)

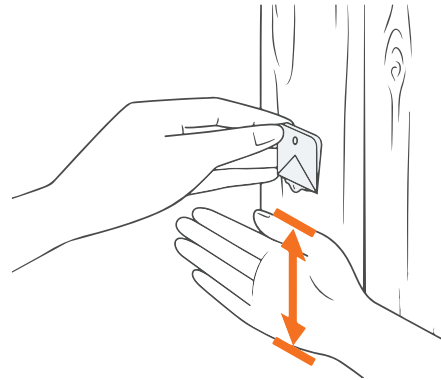

Choose 3 locations

Pin the cards 12 cm from the ground with the orange triangle facing up

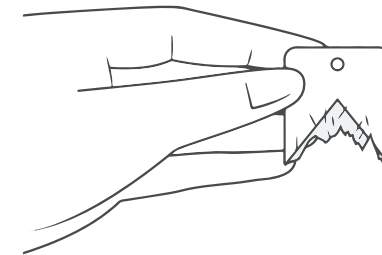

Leave out overnight

Check for bite marks. If yes, put your trap there - if no, try another location

If you see bite marks on your card, move your trap there — If not, try another location

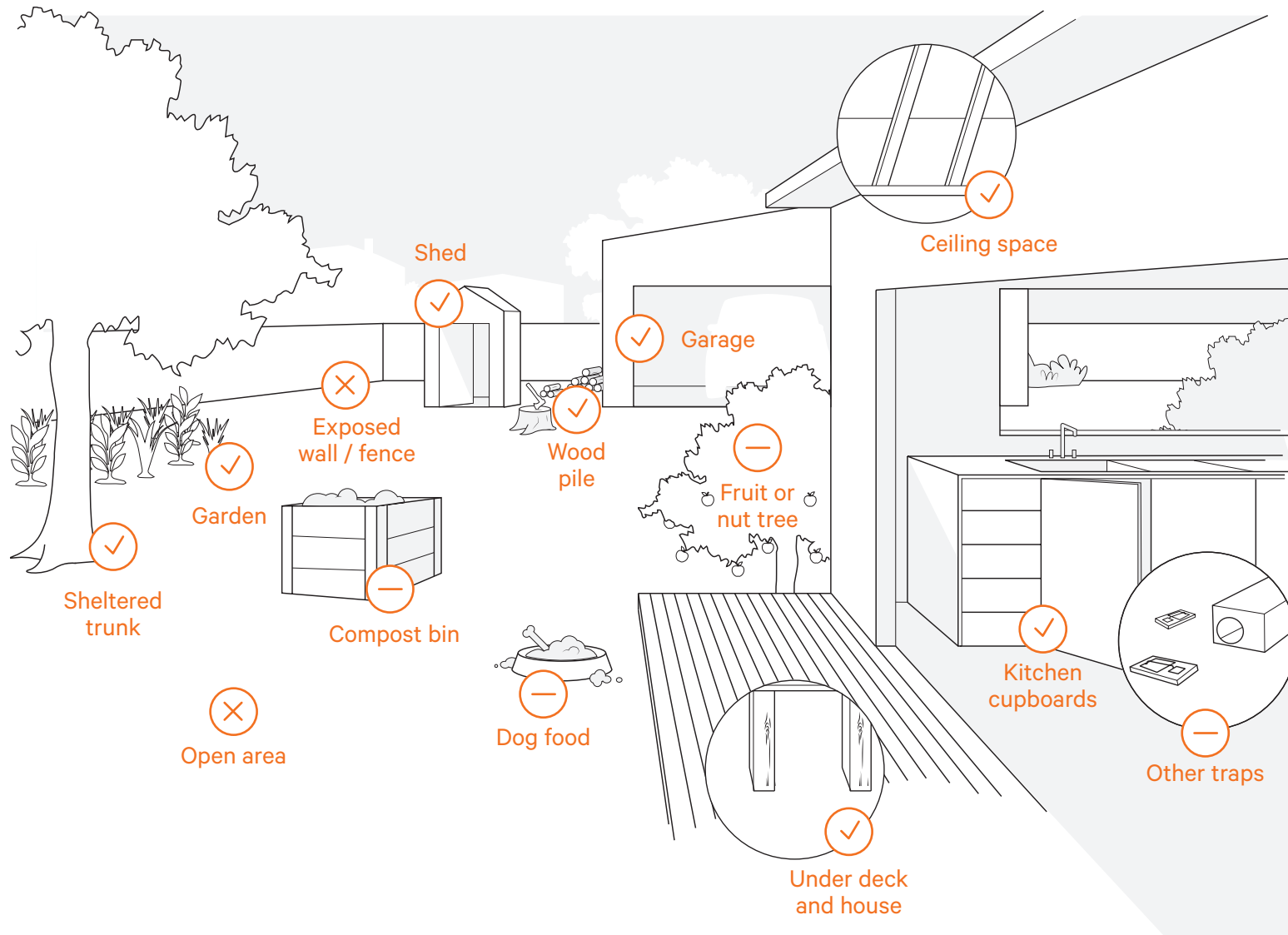

✗ Rats and mice are always on the run! They won't stop in areas they feel unsafe or threatened – like open and exposed areas.

– Remove all competing foods sources to break their food habits. Seal off your compost bin, remove pet food and place your trap away from fruit or nut trees and other traps or bait stations.

✓ Set your Trap Location Cards in sheltered areas, these are the best locations because rats and mice will feel safe enough to interact with the new food source.

✓ Trap Location Cards give rats and mice a taste of the lure and introduce new feeding habits. As it's the same lure that's in your trap, when they go looking for more, they'll find it in your trap!

The A24 Trap Stand allows you to set up your trap indoors or when there is no tree or post handy.

If you find you're moving your A24 around often, the Trap Stand lets you safely move your trap without having to de-gas it.

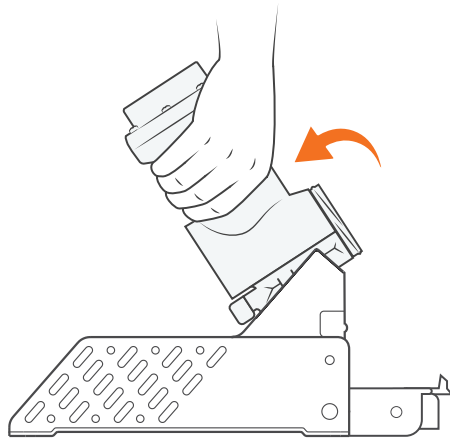

Attach the A24

Open the Stand lock and slide the A24 onto the Trap Stand

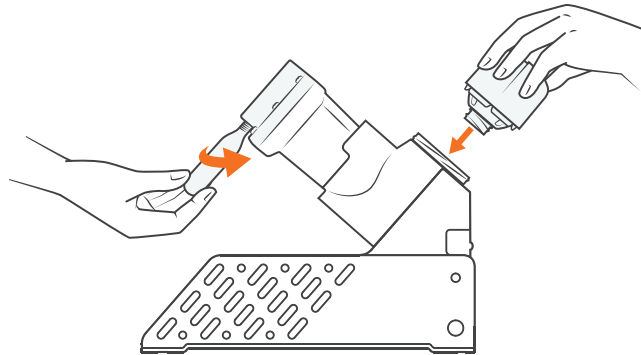

Install Gas & APP

Keep your A24 powered and attractive for up to 6 months



Easily relocate

Safely move to another spot, without having to de-gas your A24

Once the gas is installed, the trap is live! Keep your hands clear from the trap entrance

You also have the option to install your A24 onto a tree or post using the Tree Mount included.

Full step-by-step installation instructions are included in your Smart Trap Kit or you can find them in the Goodnature App. You can also find our video resources and answers to common questions at goodnature.co.nz on the Discover and Support pages.

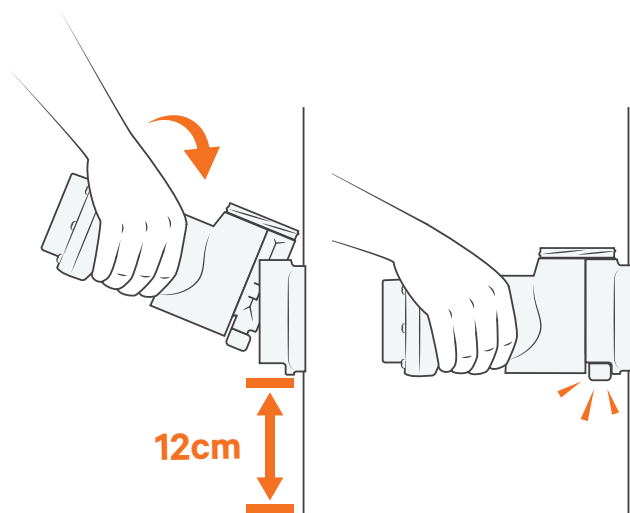

Attach the A24

Screw the Tree Mount to a tree or post and attach the A24

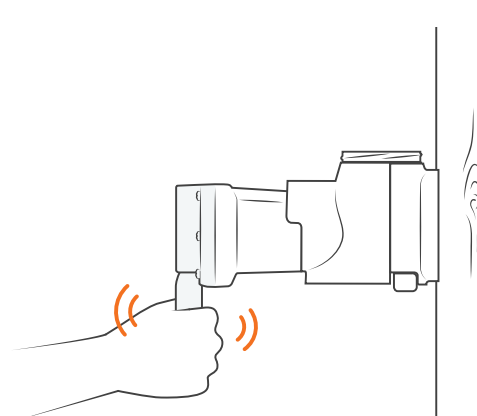

Power up the Trap

Screw in the Gas Canister to power your A24 Trap

 **The trap is now live**

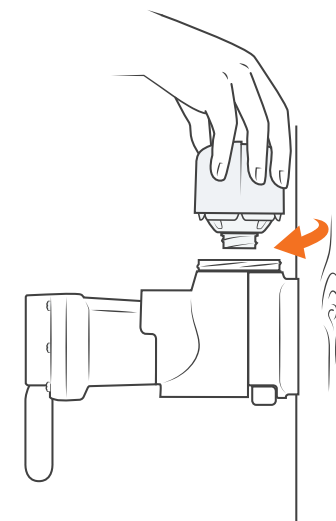

Secure the Cap

Activate, push the Automatic Paste Pump into the cap, remove the lid and screw onto the Trap

A single Gas Canister and Automatic Lure Pump will last up to 6 months before you need to replace them

The Automatic Paste Pump (APP) is a small silver pouch filled with formulated, toxin-free lure and once activated, continuously feeds your trap with fresh lure, keeping your A24 attractive to rats and mice for up to 6 months.

The APP is made from two chambers, one filled with lure and the other empty. Once activated, gas is generated, filling up the empty chamber and forcing the lure out the lower chamber.

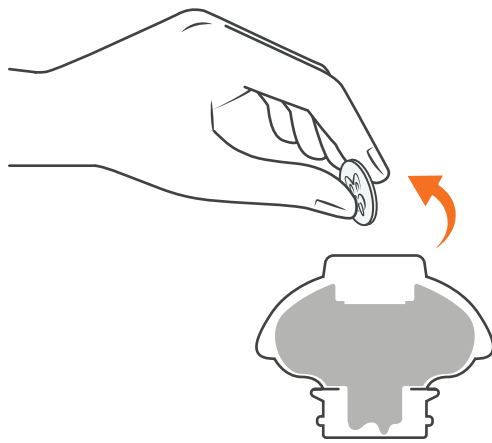

Day 1

Activate by removing the 10c coin

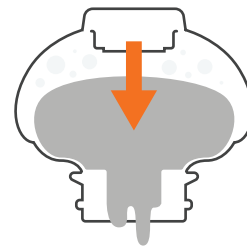

Day 90

The top chamber slowly inflates, pushing fresh paste out



Day 180

After 6 months when it's fully inflated, it's time to replace



Pet Safe



Non-toxic

The APP dispenses fresh, toxin-free paste and drops below the trap to pre-feed the site

Apply the pre-feed around and leading up into your trap to introduce a new “safe food” and help combat food competition. This introduces new habits and gives pests a taste of what’s in your trap.



Remove competing food

Block off rubbish bins, your compost, pet food or any other food sources

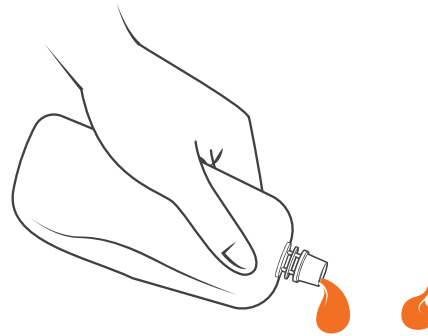

Pre-feed your site

Rodents will become familiar with the paste as a safe source of food



Stop pre-feeding

Rodents will search for more lure, leading them to the lure in your trap!



Pet Safe



Non-toxic

Pre-feed your site with toxin-free paste to give pests a taste of what’s inside your A24

Our Automatic Paste Pump and Pre-feed Pouch are available in two flavours; Chocolate and Nut Butter. Each equally effective, choose the lure that works best in your environment.



Chocolate
For Rats & Mice

Nut Butter
For Rats & Mice

Use the matching pre-feed and Automatic Paste Pump to attract pests to your A24 Trap

Our toxin-free paste is available in three products. Each plays a unique and important role in the trapping process and is designed for no fuss and no mess.

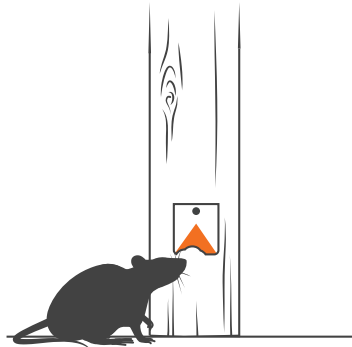

Trap Location Cards

Use Trap Location cards to find the rodent hotspots

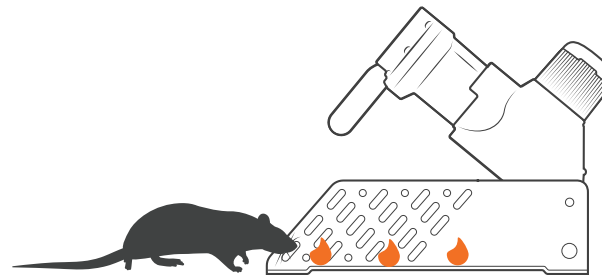

Pre-feeding

Pre-feeding encourages pests toward your trap & away from any competing food sources



Automatic Paste Pump

The Automatic Paste Pump continuously releases fresh paste to attract rodents into the A24 Trap

Our range of toxin-free paste has been designed to be used together for best success