

# Goodnature

## Welcome Pack



goodnature®



# Goodnature® Rat & Mouse Traps

Rewild your world.

**When rats or mice come calling, there's never just one.** The A24 Goodnature Rat & Mouse Traps have everything you need to get on top of your rodent problem, with a rat and mouse trap that's automatic, non-toxic and delivers a quick and humane kill.

Automatic Non-toxic Humane



## Goodnature® Rat & Mouse Traps



**Smart Trap Kit**  
GNK-A24A-017  
94-21905-48315-5



**6 Month Top-up Choc:** GNK-009  
94-21905-48312-4



**6 Month Top-up Nut butter:** GNK-010  
94-21905-48313-1

**CLICK HERE  
TO SEE  
GOODNATURE  
IN ACTION**

# goodnature®

Ⓢ Automatic Ⓢ Non-toxic Ⓢ Humane

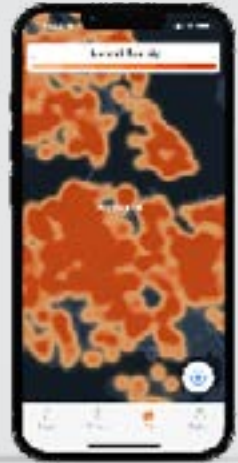

## Benefits

### Set and forget with long-term, automatic protection against rodents

Constant control. These traps automatically reset themselves, killing pests one after another, dispensing fresh lure for six months. Kill up to 24 pests before you need to replace the CO2 or lure

### Safe, poison-free trapping

A solution that not only effective, but also poison-free and safe to use. Goodnature traps are designed to target specific pests, nothing else

### A Humane, swift and effective kill

Goodnature traps deliver an instant and humane kill and have been independently tested to meet the highest international standards - NAWAC Humane A-class certified

### Bluetooth connectivity to your phone

Count your kills and be notified when to top up your lure and gas.

### Kill density heat map

Join a global community of pest control.

### Easy to use, move and maintain

We've done a whole lot of head-scratching so you don't have to - traps are easy to set up with multiple mounting options to move between locations, indoors and out

### Identify optimal locations for your trap

Lure Taste scratch cards indicate pest movement paths, identifying optimal trap location or enhance pest attraction toward the lure flavour and trap

### Complete with 6 months of automatic, non-toxic trapping

Get stated straight away with a six month supply of gas and lure included international standards.

### How it works:

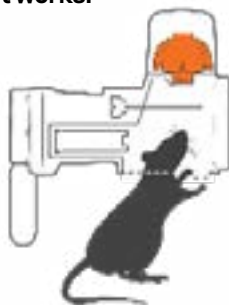

**Sniff sniff**  
Lure attracts pest into the trap

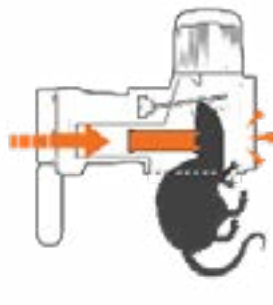

**Kapow!**  
Pest moves trigger, firing the trap



**Auto-reset**  
The pest drops as the trap resets itself



**Sniff sniff...**  
Lure continues to attract pests for constant control

# Features and Benefits Summary

## Category description:

When rats or mice come calling, there's never just one. The A24 Goodnature Rat & Mouse Trap provides everything you need to get on top of your rodent problem, with a rat and mouse trap that's automatic, non-toxic and delivers a quick and humane kill.

## Smart Trap Kit

GNK-A24A-017

- World's smartest trap
- Bluetooth smartphone connection and Goodnature App
- Automatic, non-toxic and humane

## Brief Summary:

Long-term, automatic pest control made easy. The Smart Trap Kit has everything you need to control pests confidently and efficiently. The Smart Cap records each time a pest is killed - including the day, time and air temperature, updating the app via Bluetooth when you visit your trap for maintenance.

## Detailed Summary/Goodnature App:

With 24/7 monitoring, you'll know what your trap has been up to. The Smart Cap keeps count of each pest your trap has killed. Even if you haven't seen any pests under your trap, you'll know how many you're killing. The Goodnature app also notifies you when you need to replace your automatic paste pump and gas canister, keeping your trap fresh and ready for action. This pack comes complete with a six month supply of gas and paste so you can get started straight away.

## What's in the box:

- A24 Rat & Mouse Trap
- Smart Cap attachment
- Tree Mount and screws
- CO2 canister
- Non-toxic rodent paste
- Trap Location Cards (x3)
- Trap Stand

goodnature®



### **Benefit/feature:**

#### **Set and forget with long-term, automatic protection against rodents**

Constant control. These traps automatically reset themselves, killing pests one after another, dispensing fresh paste for six months. Kill up to 24 pests before you need to replace the CO2 or paste.

#### **Safe, poison-free trapping**

A solution that's not only effective, but also poison-free and safe to use. Goodnature pastes are completely toxin free, there's no risk of secondary poisoning, making it safe to use around pests, wildlife and children.

#### **A Humane, swift and effective kill**

Goodnature traps deliver an instant and humane kill and have been independently tested to meet the highest international standards - NAWAC Humane A-class certified.

#### **Identify optimal locations for your trap**

For best results, it's important you assess (not guess) where to position your trap using the Trap Location Cards. These cards contain an attractive paste and enhance pest attraction toward the paste flavour and trap

#### **Complete with 6 months of automatic, non-toxic trapping**

Get started straight away with a six month supply of gas and paste included.

#### **Track your kills, 24/7 - with Bluetooth connectivity**

The Smart Cap records/counts each time a pest is killed - including the day, time and air temperature, updating the app via Bluetooth when you visit your trap for maintenance.

#### **Guided installation and trapping tips**

Within the Goodnature App you'll have all you need right at your fingertips. The App will guide you through installation, ongoing trap maintenance and help answer any questions.

goodnature®



### **Be notified when to replenish you trap**

App notifications alert you when you need to replace your paste and gas, keeping your trap fresh and ready for action, and helping provide constant control against pests.

### **Share your trapping data with others**

Sharing data with the Goodnature App is simple and means others can help maintain your trap and monitor your success too. Perfect if you're working with your community to solve a pest problem together.

### **Join a global community of conservation**

The Goodnature App shows you how your individual trapping success adds up to something much bigger for global pest control with an integrated kill density heat map.

goodnature®



# goodnature®

## **Smart** Trap Kit

Retail Training Guide for the  
A24 Rat & Mouse Trap Kits.

---



Made in New Zealand



### Standard or Smart Cap Attachment

The Smart Cap sends trap data to your smartphone via the Goodnature App

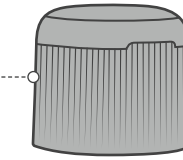

### Automatic Paste Pump

Silver foil pouch that slowly releases fresh and attractive paste over 6 months



### A24 Trap

A self-resetting trapping mechanism that humanely kills the rodent

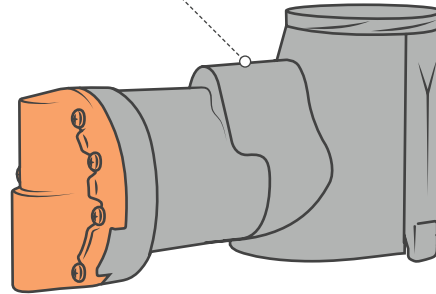

### CO2 Gas Canister

Powers your trap for 6 months or 24 kills



### Trap Stand

Allows for flexible movability around the property indoors and outdoors

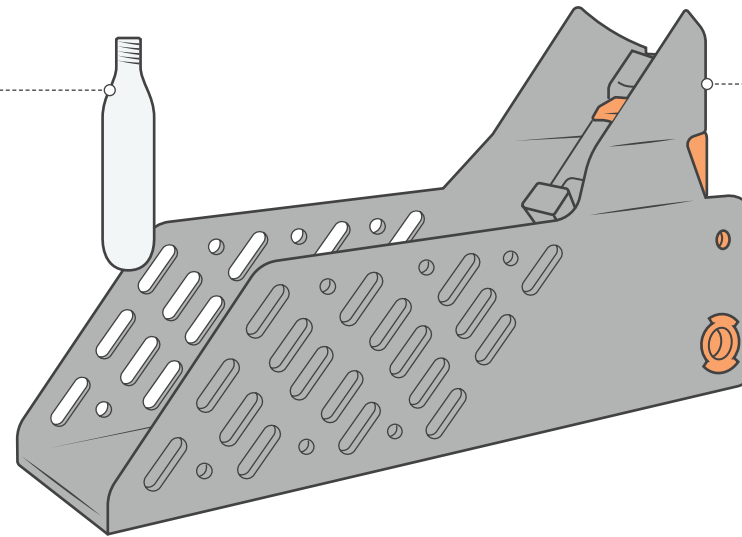

It's called an A24 because it automatically resets 24 times per gas canister





Pet Safe



Non-toxic

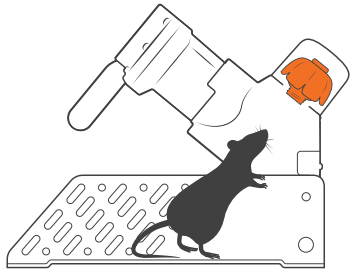

### Sniff sniff

Non-toxic paste attracts pests into the trap

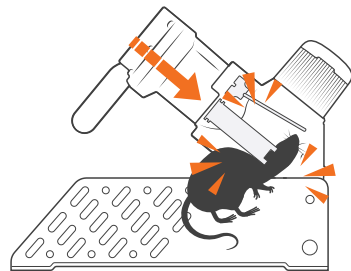

### Kapow!

Pest moves the trigger, firing the trap

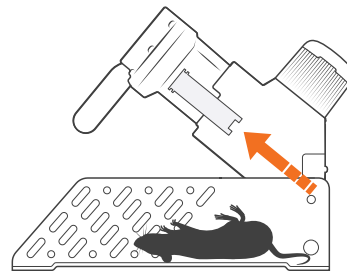

### Auto-reset

Pest drops as trap resets itself

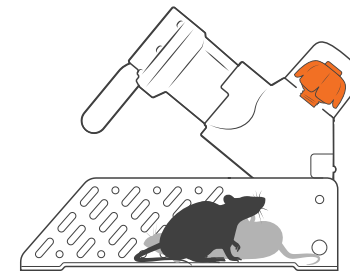

### Sniff sniff

Paste continues to attract pests for 6 months

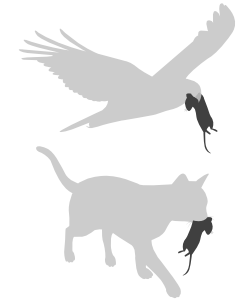

### Scavenged

Dead pests are scavenged from below the trap

The A24 Trap, humanely kills pest, helping to protect our native species and wildlife

This is the most important step in setting up your A24 Trap, as a chewed up card indicates where you should install your trap for greater success.

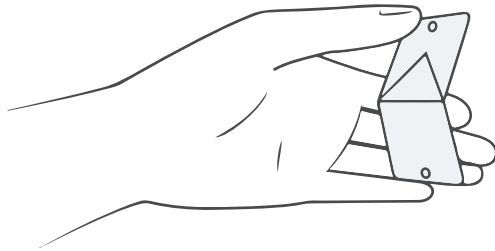
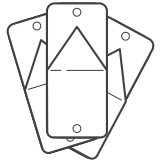

### Fold in half

A small amount of paste should squeeze out the middle (for attracting rodents)

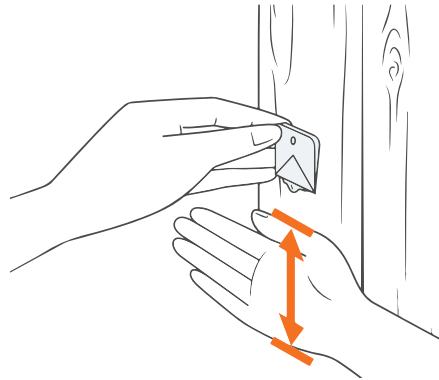

### Choose 3 locations

Pin the cards 12 cm from the ground with the orange triangle facing up

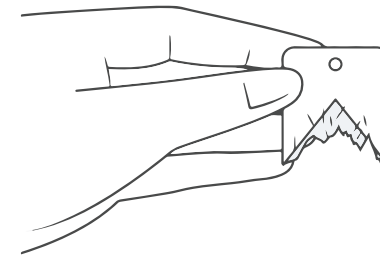

### Leave out overnight

Check for bite marks. If yes, put your trap there - if no, try another location

**If you see bite marks on your card, move your trap there — If not, try another location**

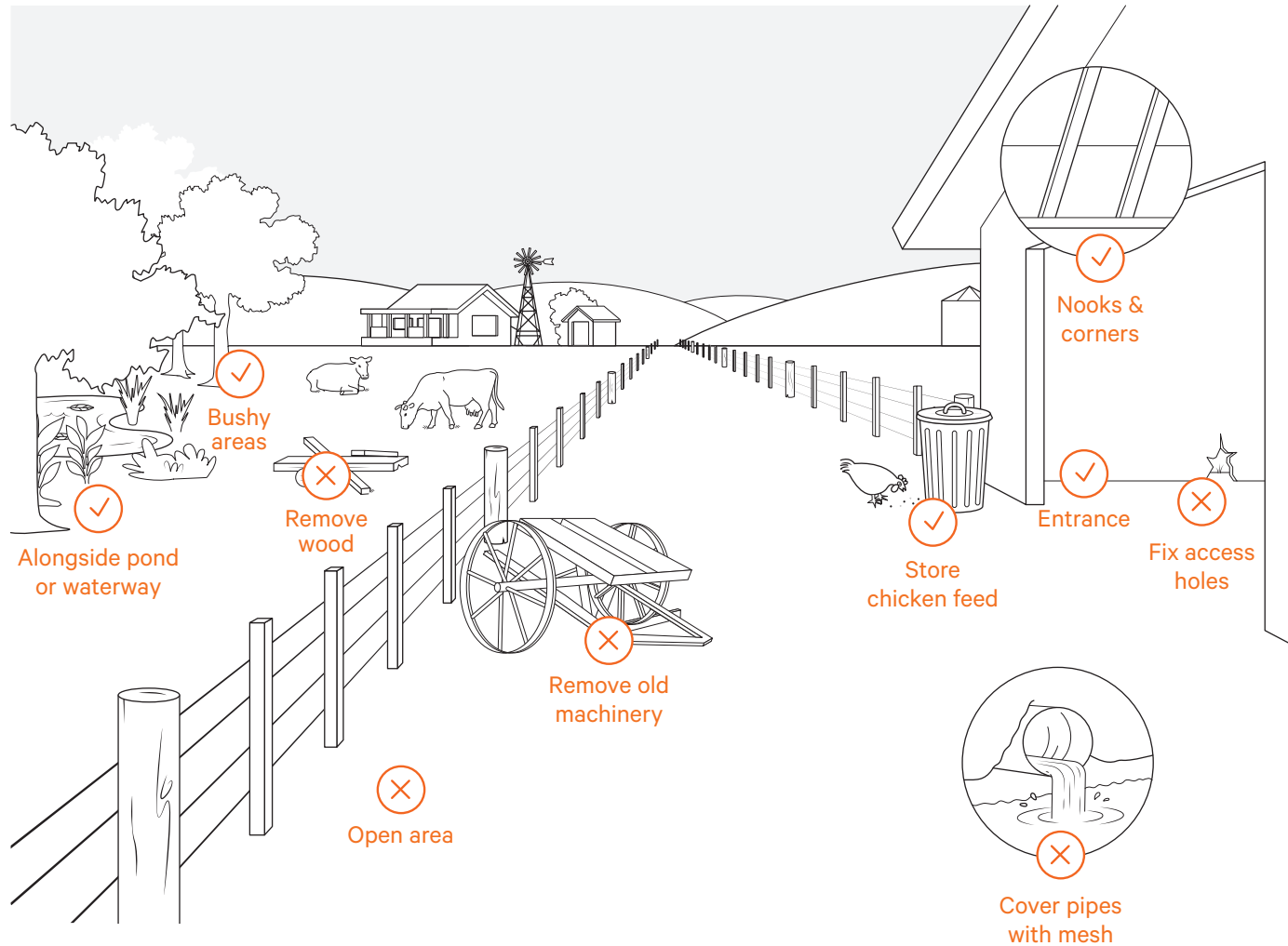

✗ Clear away obsolete machinery, such as wood and building materials around the farm to reduce rodent hiding places.

✗ Store any food sources, such as chicken feed or dog food, in sealed containers and reduce access to other feed and seed storage areas and silos by installing mesh in drains and pipes, and fixing access holes.

✓ Good places for your traps are inside buildings, near doors or openings, and in nooks and corners. Ideal outdoor locations are near bushy areas alongside waterways, hedges and ponds as rats usually follow the water edge.

✓ Rats and mice are more likely to stop and eat in a sheltered place where they feel safe.

# Trap Location Cards

## Where to Put Your Trap Location Cards at Home

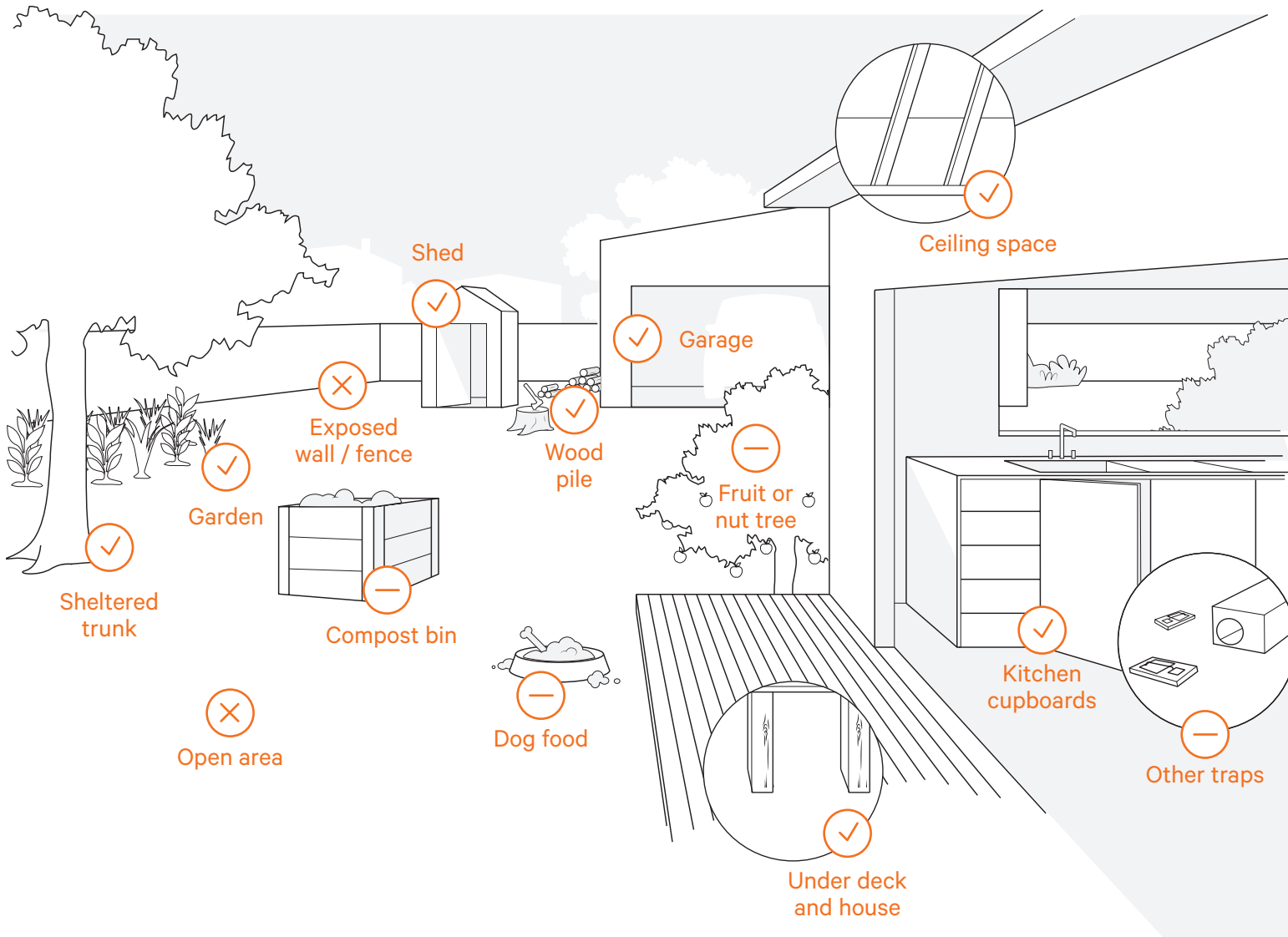

✗ Rats and mice are always on the run! They won't stop in areas they feel unsafe or threatened – like open and exposed areas.

– Remove all competing foods sources to break their food habits. Seal off your compost bin, remove pet food and place your trap away from fruit or nut trees and other traps or bait stations.

✓ Set your Trap Location Cards in sheltered areas, these are the best locations because rats and mice will feel safe enough to interact with the new food source.

✓ Trap Location Cards give rats and mice a taste of the lure and introduce new feeding habits. As it's the same lure that's in your trap, when they go looking for more, they'll find it in your trap!

Trap Location Cards show you where pests feel safe to interact with their environment and investigate the trap

The A24 Trap Stand allows you to set up your trap indoors or when there is no tree or post handy.

If you find you're moving your A24 around often, the Trap Stand lets you safely move your trap without having to de-gas it.

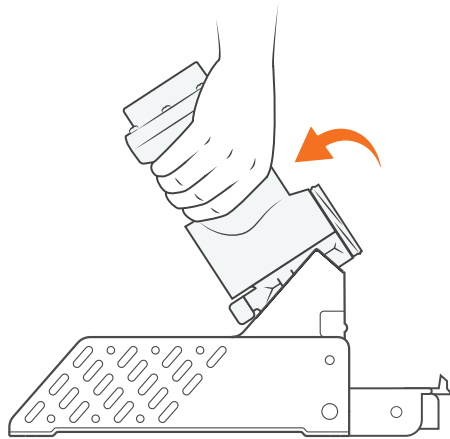

### Attach the A24

Open the Stand lock and slide the A24 onto the Trap Stand

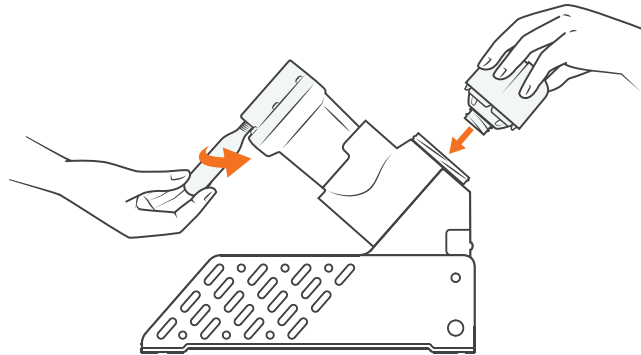

### Install Gas & APP

Keep your A24 powered and attractive for up to 6 months



### Easily relocate

Safely move to another spot, without having to de-gas your A24

Once the gas is installed, the trap is live! Keep your hands clear from the trap entrance

You also have the option to install your A24 onto a tree or post using the Tree Mount included.

Full step-by-step installation instructions are included in your Smart Trap Kit or you can find them in the Goodnature App. You can also find our video resources and answers to common questions at [goodnature.co.nz](http://goodnature.co.nz) on the Discover and Support pages.

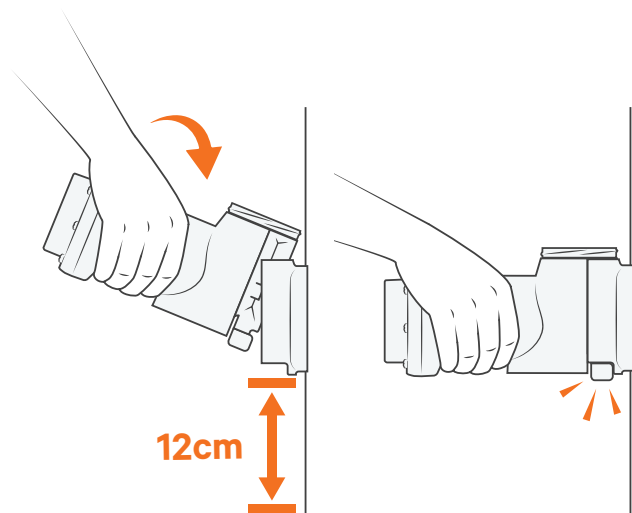

## Attach the A24

Screw the Tree Mount to a tree or post and attach the A24

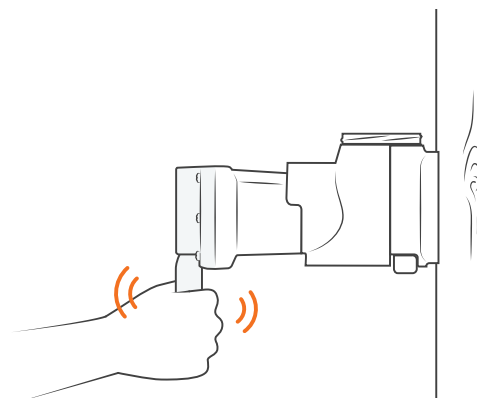

## Power up the Trap

Screw in the Gas Canister to power your A24 Trap

 **The trap is now live**

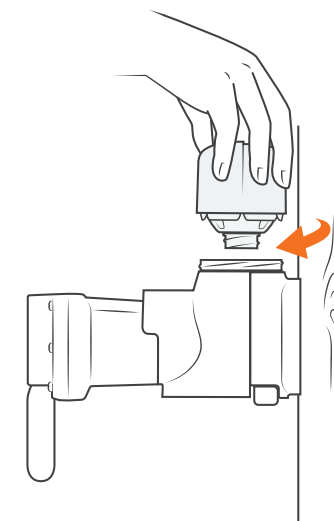

## Secure the Cap

Activate, push the Automatic Paste Pump into the cap, remove the lid and screw onto the Trap

**A single Gas Canister and Automatic Lure Pump will last up to 6 months before you need to replace them**

The Automatic Paste Pump (APP) is a small silver pouch filled with formulated, toxin-free lure and once activated, continuously feeds your trap with fresh lure, keeping your A24 attractive to rats and mice for up to 6 months.

The APP is made from two chambers, one filled with lure and the other empty. Once activated, gas is generated, filling up the empty chamber and forcing the lure out the lower chamber.

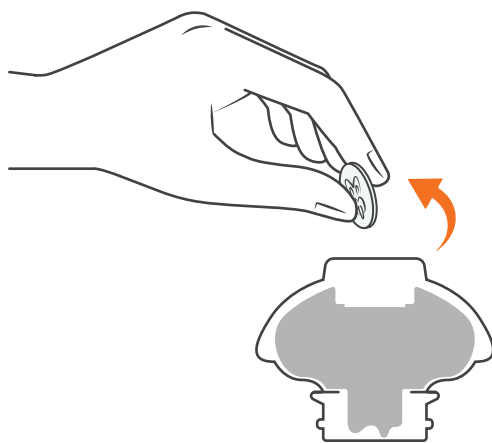

**Day 1**

Activate by removing the 10c coin

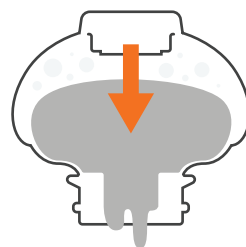

**Day 90**

The top chamber slowly inflates, pushing fresh paste out



**Day 180**

After 6 months when it's fully inflated, it's time to replace



Pet Safe



Non-toxic

The APP dispenses fresh, toxin-free paste and drops below the trap to pre-feed the site

Apply the pre-feed around and leading up into your trap to introduce a new “safe food” and help combat food competition. This introduces new habits and gives pests a taste of what’s in your trap.



### Remove competing food

Block off rubbish bins, your compost, pet food or any other food sources

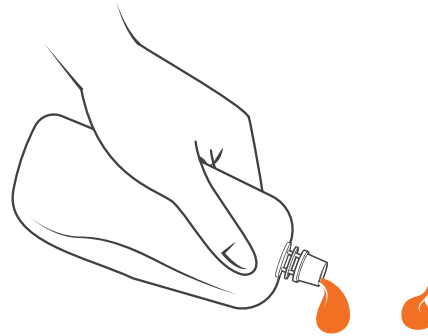

### Pre-feed your site

Rodents will become familiar with the paste as a safe source of food



### Stop pre-feeding

Rodents will search for more lure, leading them to the lure in your trap!



Pet Safe



Non-toxic

Pre-feed your site with toxin-free paste to give pests a taste of what’s inside your A24



Our Automatic Paste Pump and Pre-feed Pouch are available in two flavours; Chocolate and Nut Butter. Each equally effective, choose the lure that works best in your environment.



Use the matching pre-feed and Automatic Paste Pump to attract pests to your A24 Trap

Our toxin-free paste is available in three products. Each plays a unique and important role in the trapping process and is designed for no fuss and no mess.

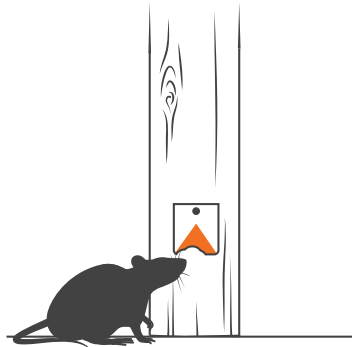

### Trap Location Cards

Use Trap Location cards to find the rodent hotspots

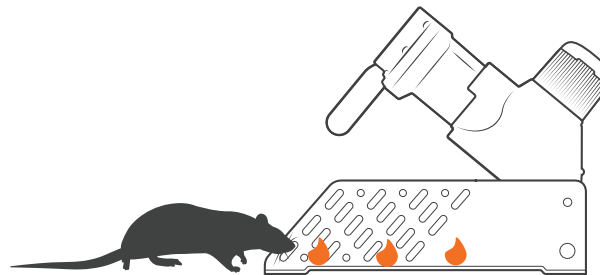

### Pre-feeding

Pre-feeding encourages pests toward your trap & away from any competing food sources



### Automatic Paste Pump

The Automatic Paste Pump continuously releases fresh paste to attract rodents into the A24 Trap

Our range of toxin-free paste has been designed to be used together for best success

The Smart Cap gives you more data, so when your trap has killed a pest, it records the day, time and air temperature at the time of kill. When you check your trap, the Smart Cap sends this data to the Goodnature App via Bluetooth™.

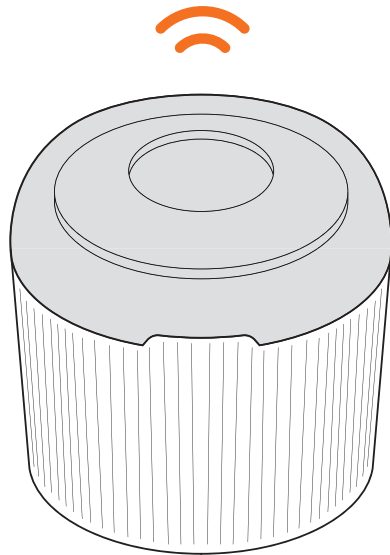

### Smart Cap

The Smart Cap sits in the top of the A24 Trap and can be installed to upgrade any existing A24

### Your Traps

The total numbers of kills across your traps

### Your humane kills

Information including number of kills and the date, time and temperature they occurred

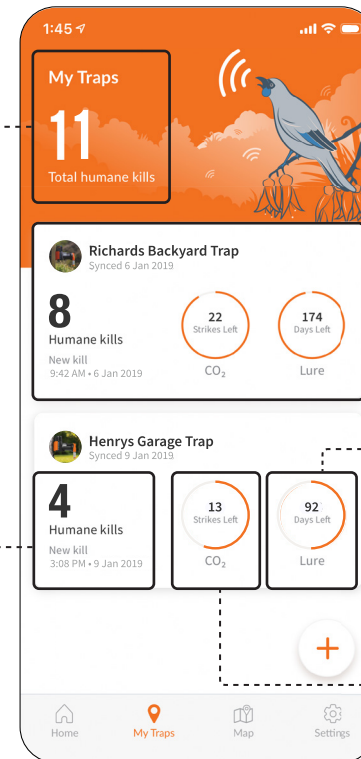

### Trap Card

Information for each trap including kill information and CO<sub>2</sub> and lure levels

### Paste levels

Tells you when the Automatic Paste Pump needs to be changed to keep your trap as attractive as possible

### Gas levels

Indicates how many strikes are left in your A24 before the Canister needs to be replaced

The Smart Cap upgrades your A24 so you can access the trap's data through the Goodnature App

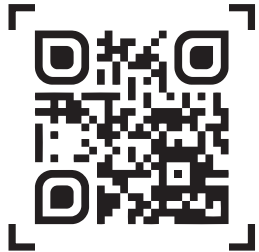

1. Download the free Goodnature App
2. Follow the in-app instructions to install your A24
3. Pair with the Goodnature App
4. Attach the Smart Cap to your A24 and you're ready to go
5. When you check your trap, collect your data with the Goodnature App



### Download the Goodnature App

Download the Goodnature App, create an account and follow the instructions

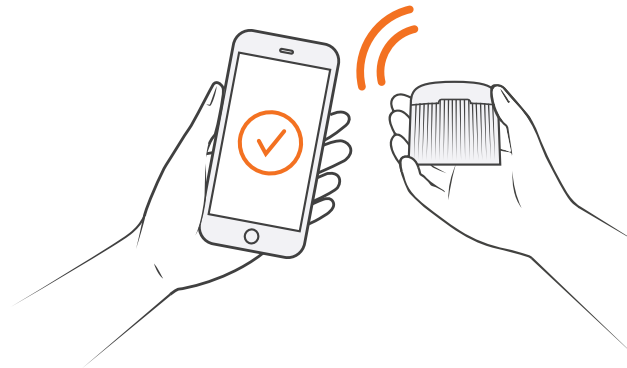

### Pair with the Goodnature App

Once your trap is installed, pair your Smart Cap so the App can receive your trap's data

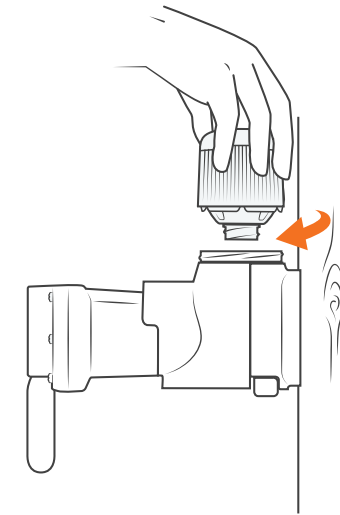

### Install the Smart Cap

Twist the Smart Cap onto your A24. You can now receive trap data via the Goodnature App

 **Pair at your trap site to set the location**

**Download the Goodnature App and read the in-app instructions before installing your A24**

### Getting it right from the start

1. To get started press “Set up my Trap”
2. Set up Trap Locator Cards if you haven't, these assess your area to find the best location for your trap.
3. Once you have a location, install your trap. The step-by-step instruction guide will take you through this process.
4. Pair your Smart Cap using the app.
5. Once you've successfully paired, finish off the instructions and you're good to go!

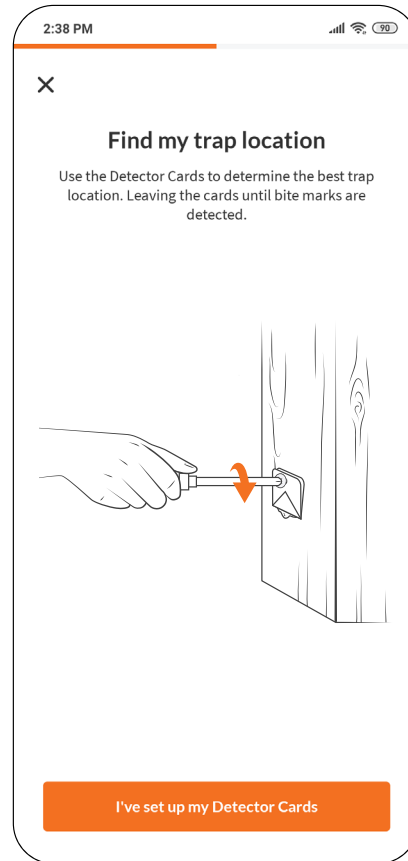

### Trap Activity

Here is where you see the time, date and air temperature of each kill.

The Goodnature App will let you know when you need to top up your gas and lure.

### Edit Trap

If you move your trap here's where you update your trap's new location.

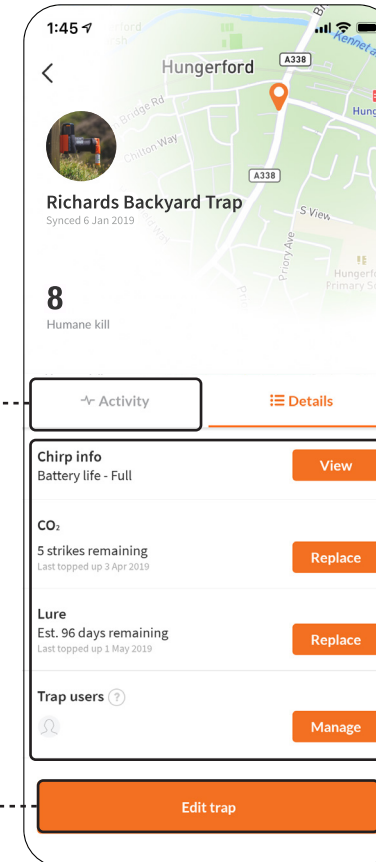

### Manage your Traps

Click on the Trap Card to reveal your trap details.

### Trap Details

View your Smart Cap's battery level, manage your gas and lure and see who else can access your trap's data.

## Set up basics

To reduce the amount of packaging material, and so you always have your instructions handy, all the instructions are in the Goodnature App.

1. Download the app and set your account. The Goodnature app is free to download on Google Play or the App Store.
2. Remove the battery tab in a dry location, replace with the positive side facing upwards and click back together.
3. Pair the Smart Cap to the Goodnature App at your trapping site to record your trap's GPS location.

Bluetooth must be on to set up and collect data.

iOS users: Set the locations permission to 'Always'. We're not using this data, this allows your smartphone to detect and connect in the background. If you don't set this, you won't be able to pair with your Smart Cap.

---

## Collecting data from the Smart Cap

Ensure your Bluetooth is on and the Goodnature App is open.

If your App hasn't received a notification, remove the Smart Cap and turn upside down, then replace the cap back onto A24 – This action will push data stored in the Smart Cap to your app.

If your trap has no activity to report, the "Last Synced" field will update in the activity log.

The Smart Cap uses Bluetooth to send data to the Goodnature App on your smartphone.

---

## Bluetooth™

Bluetooth enables the collection of your A24's stored data in off the grid locations, so it doesn't rely on cellphone coverage or wifi. Using Bluetooth means that your Smart Trap works, no matter how remote your trap is located.

The Smart Cap will not appear in your phone's "my device" list.

## Sharing your traps

You can share your collected data with anyone else who has the Goodnature App installed.

They can see where your trap is located, the number of kills and they have the ability to replace and update your trap.

Note: When sharing your trap's data with an existing Goodnature App user you will need to send your invite to the email address they used to set up their Goodnature App account.

To share your trap:

1. Open the Goodnature app and click on the My Traps icon at the bottom of the screen and tap on the trap card you want to share.
2. Under Details, tap the "Manage" button next to Trap Users and add your friend's email address invite them to give them access your trap.

Your friend will receive an email to accept your invite.

---

## GPS location

The Smart Cap used your phone's GPS location at the time of pairing with the Goodnature app to mark your trap's location.

You can update your trap's location within the app.

---

## Battery life

Battery type: CR2477 T 3V lithium battery.

The battery will last 2 - 5 years depending on your trap's activity, the temperature and other environmental factors.

---

## Supported devices

iPhone 6S or later, running iOS 15 or higher.

Android 8 or higher.

## The Smart Cap's communication lights

The Smart Cap lights up when it's trying to say something:

- A red light flashing means it's is awake and has information ready to send to your app.
- A yellow light flashing means the Smart Cap has sent this information to your app.
- If both lights are on but not flashing, this means it's a battery test.

---

## Test-firing safely

The Smart Cap must not move for 2 minutes before test firing. The inbuilt motion detector prevents false kills from being recorded while in-transit.

Use the Test-fire Rat included with every Smart Trap Kit and follow the instructions to safely test-fire your trap.

---

## Trap Safety

Never put your hand into the trap. The A24 Trap requires a deliberate action to trigger them, this can't be done accidentally.

Always treat the trap as live. Although the gas canister has been removed, the trap may still be live with one charge remaining in its chamber. Test-fire the trap after you remove the gas canister, if the trap doesn't fire when triggered, it's safe to move.

Do not test-fire the trap while holding a trap in your hand. Ensure that the trap is either on the Tree Mount or on a Trap Stand.

Unscrewing the gas canister may cause it to freeze rapidly, use a cloth when removing the gas canister to protect your hands.

Always check with your Local/Regional Council for guidance on native species that may be protected in your area and their trapping rules and regulations.